

Parts Catalog

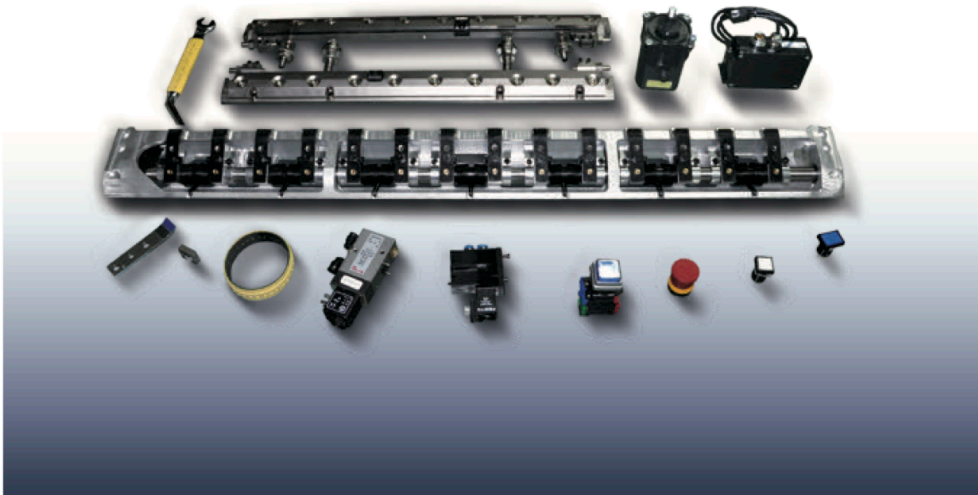

ROYO MACHINERY USA LLC
P. O. BOX 565931
MIAMI, FL 33256-5931

T: +1 786 713 0996
E: parts@royomachinery.com
E: sales@royomachinery.com

www.royomachinery.com

COMPANY PROFILE

About Us

Royo Machinery is one of the world's most experienced suppliers of new and used printing, finishing and carton converting equipment worldwide. We have sold more new and used offset printing and finishing equipment to the Caribbean and Latin American printers than any other dealer over the last 68 years. Our exceptional relationship and understanding of the region gives our company a competitive edge over competitors.

The **Royo Family** has accumulated the expertise to help you with the logistics and the engineering required to manage the process of buying and selling new and used printing, finishing and converting machinery anywhere in the world. We offer additional services such as pre-purchase inspections, dismantling and removal, parts, cleaning and painting, rebuilding and retrofitting, transportation, installation and demonstration, after sales service and warranty, appraisals and professional consultation.

Being in the industry since 1948 has allowed us to build a global network dedicated to finding the new or used printing, finishing and carton converting equipment you might be looking for at the most competitive prices. Let us help you find the Offset press, Paper Cutter, Folder, Die Cutter, Box Folder Gluer, UV Coater, Roll Sheeter or Laminator you are looking for.

Royo Machinery offers you ample possibilities to automate your finishing processes, allowing your company to be more competitive with the use of affordable smart technology investment. We know that the automation of the finishing procedures reduced the cost of labor, increasing efficiency, as well as improving the quality of the final product which at the end translates into profits. **Royo Machinery** provides quality carton and converting machinery at highly competitive prices thus ensuring complete customer satisfaction.



HEIDELBERG

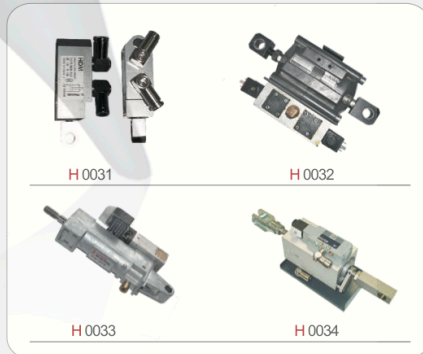
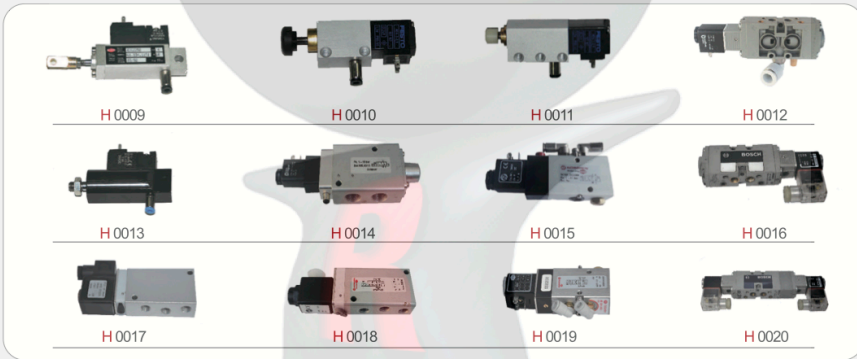
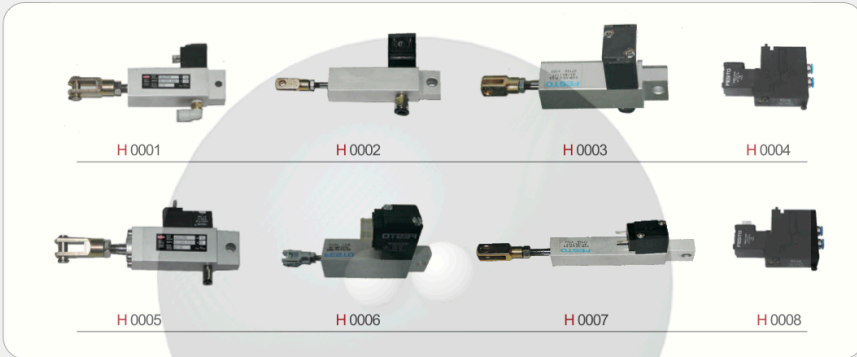

HEIDELBERG



HEIDELBERG

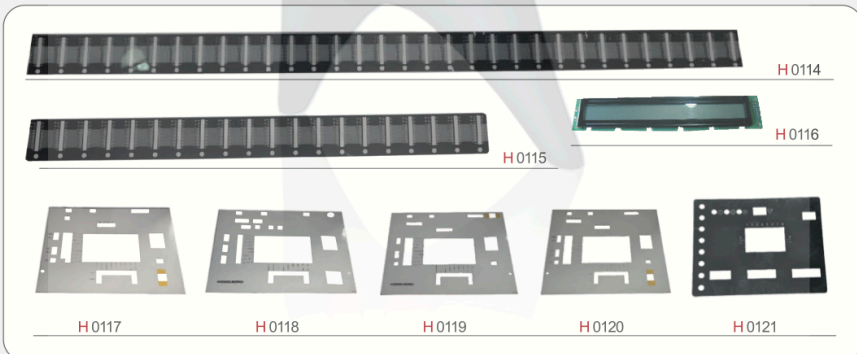

HEIDELBERG

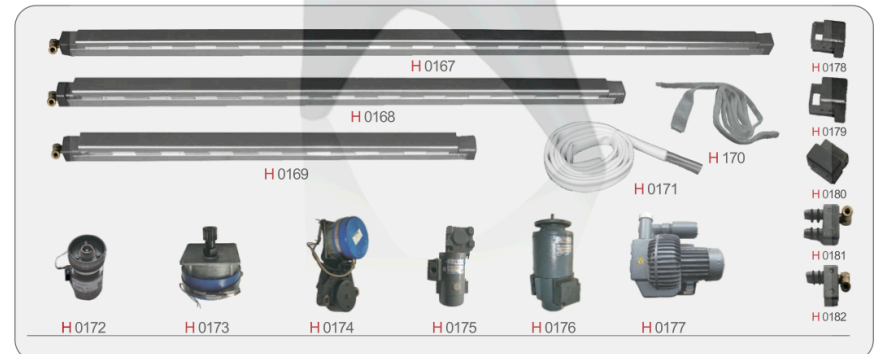
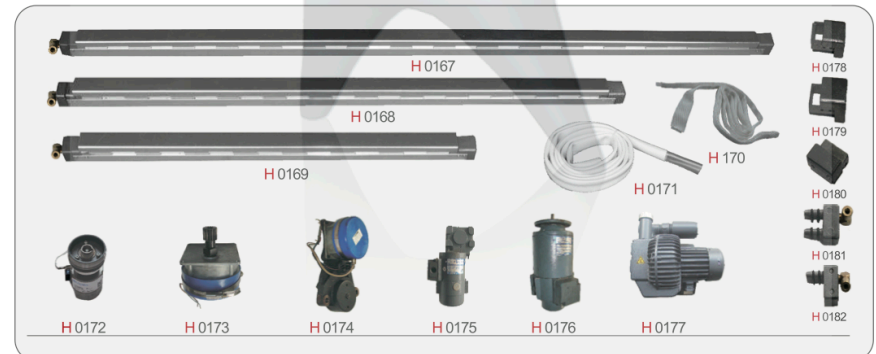
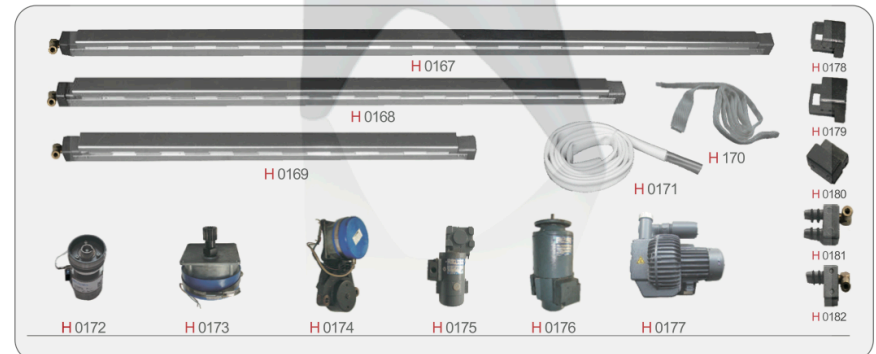

HEIDELBERG

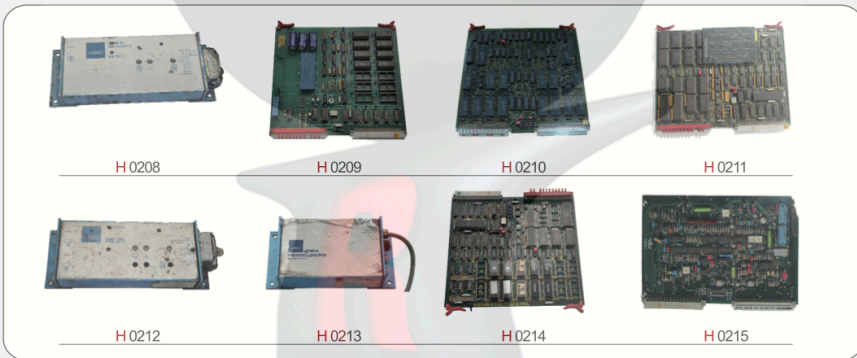
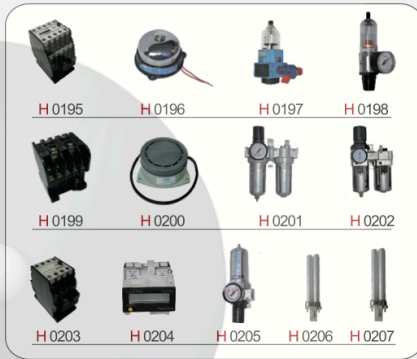

HEIDELBERG

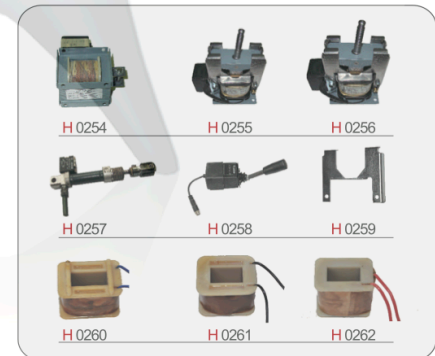
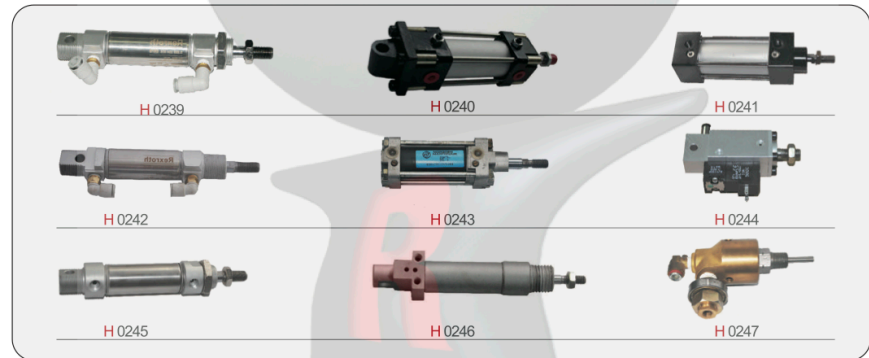
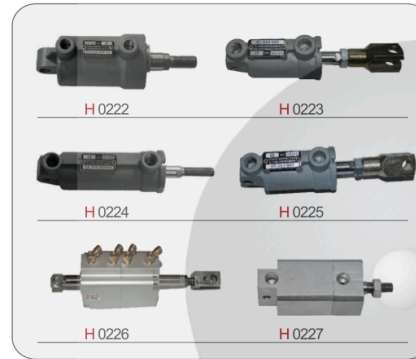

HEIDELBERG



HEIDELBERG

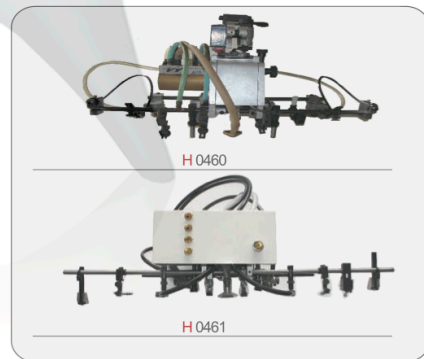

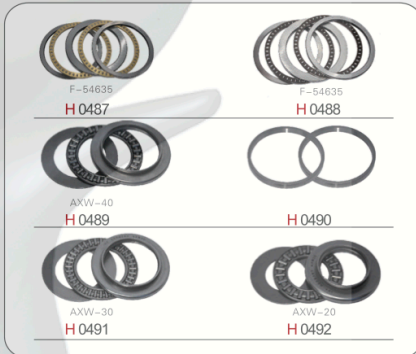
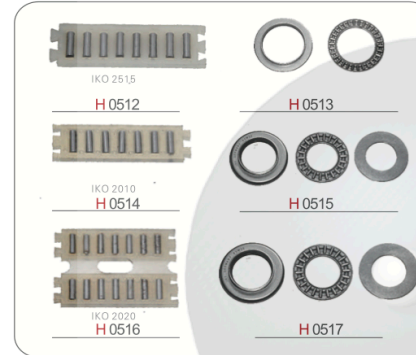





KORD
H 0558



TOK
H 0559



SM102/74/MO/GTO
H 0560

Impression Cylinder Jacket

Model	Thickness (mm)	Length (mm)	Width (mm)
GT046	0.30	456	392
GT052	0.30	518	410
SM52	0.30	532	390
M0	0.30	660	545
SM72	0.30	739	535
SM74 (NO HOLES)	0.30	758	532
SM102	0.30	1035	710

Transfer Cylinder Jacket

Model	Thickness (mm)	Length (mm)	Width (mm)
SM52	0.30	532	390
SM74 (BHOLES)	0.30	748	546
SM102 (10RIVETS)	0.30	1030	710



SM52
H 0561



SM52
H 0562



CD74
H 0563



SM102
H 0564



SM74
H 0565



GTO
H 0566

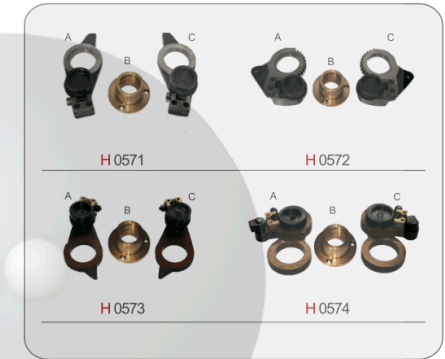
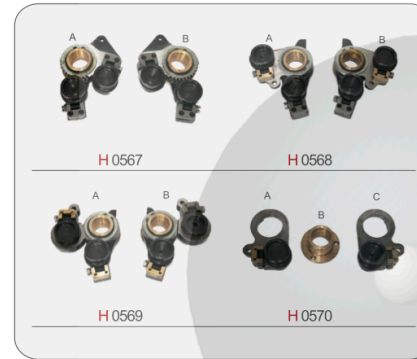

HEIDELBERG

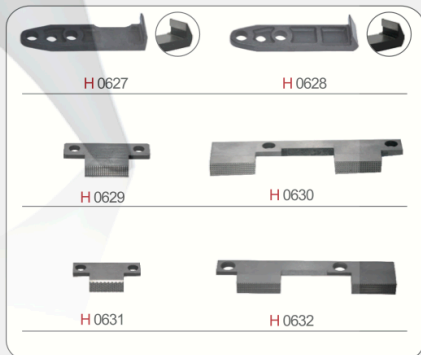
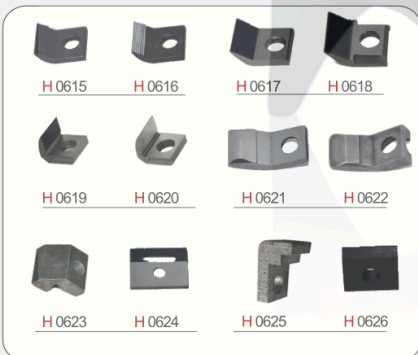
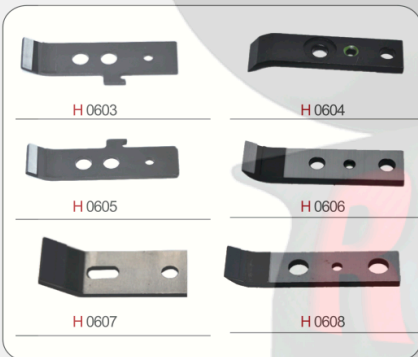

HEIDELBERG



HEIDELBERG

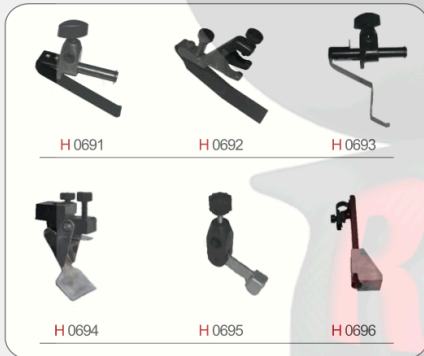
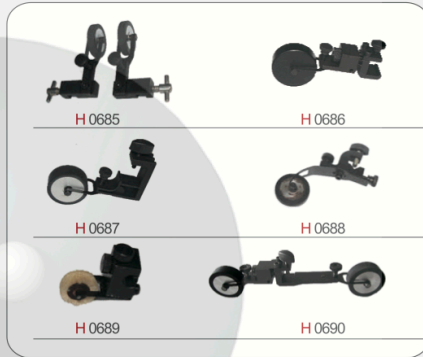
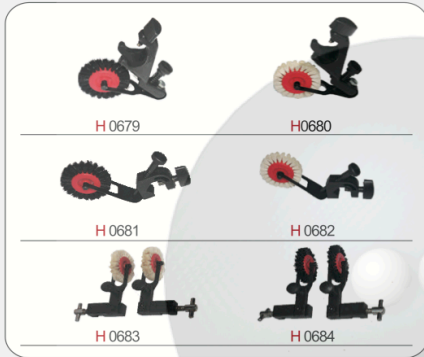

HEIDELBERG

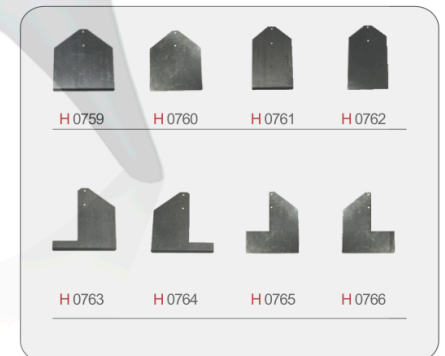
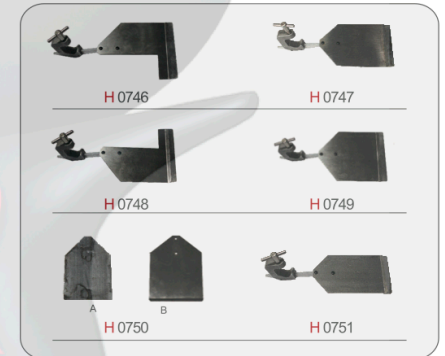
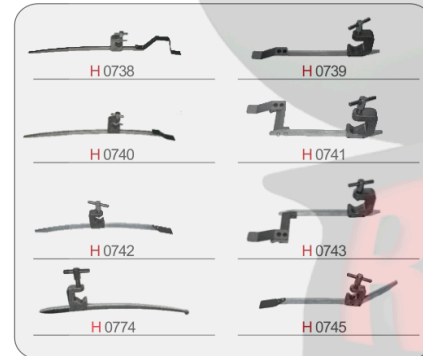

HEIDELBERG



HEIDELBERG



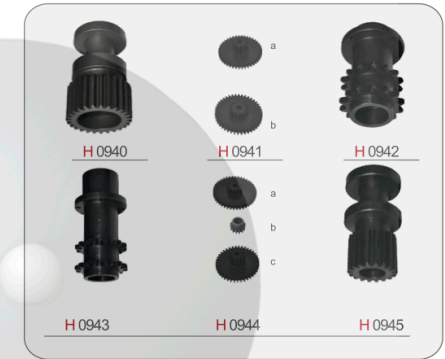
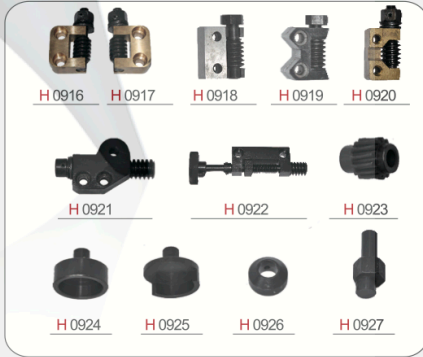

HEIDELBERG

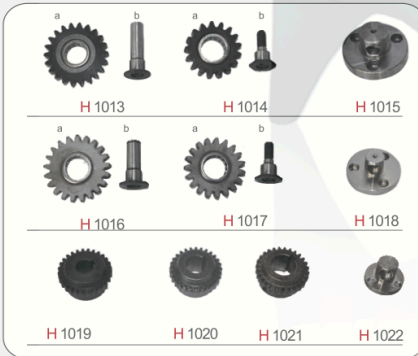

HEIDELBERG

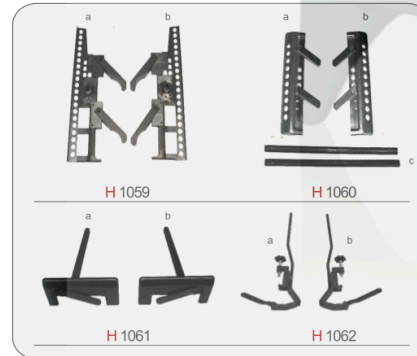
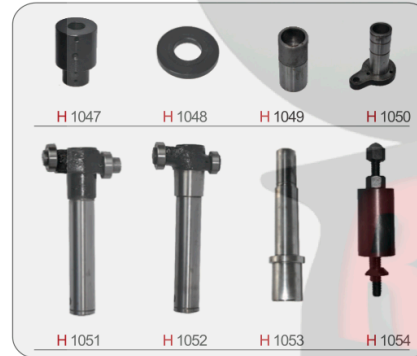

HEIDELBERG

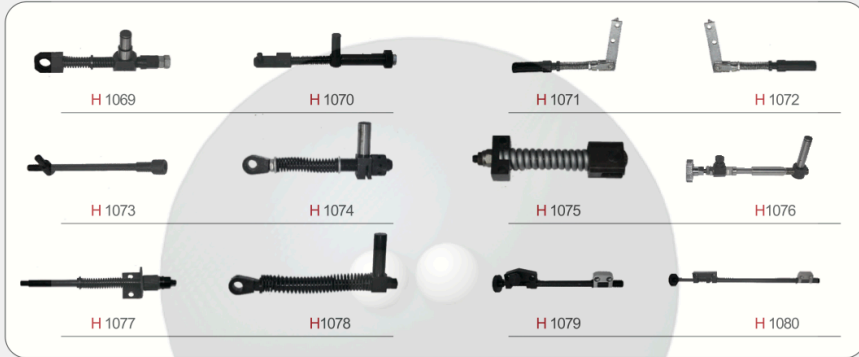

HEIDELBERG



HEIDELBERG

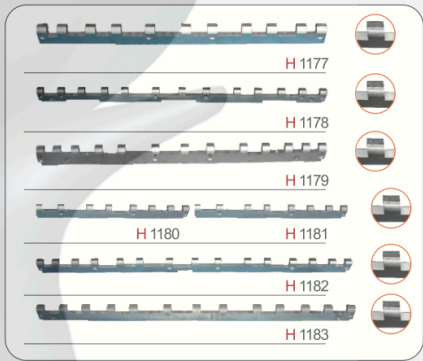
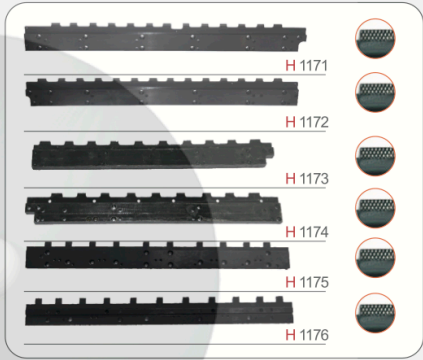
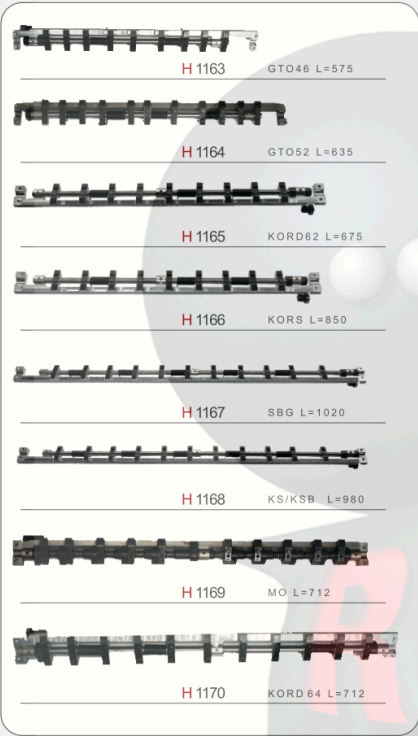

HEIDELBERG

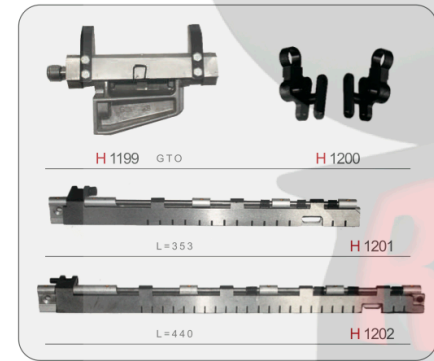

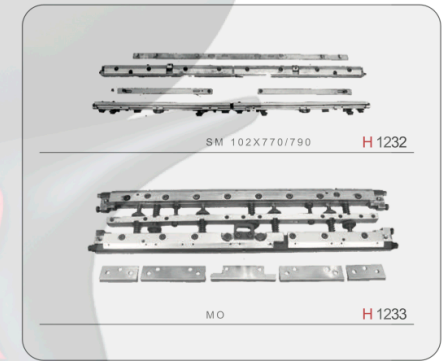
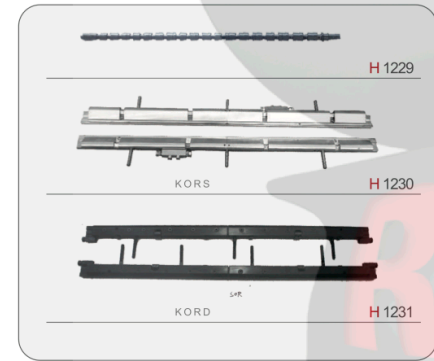
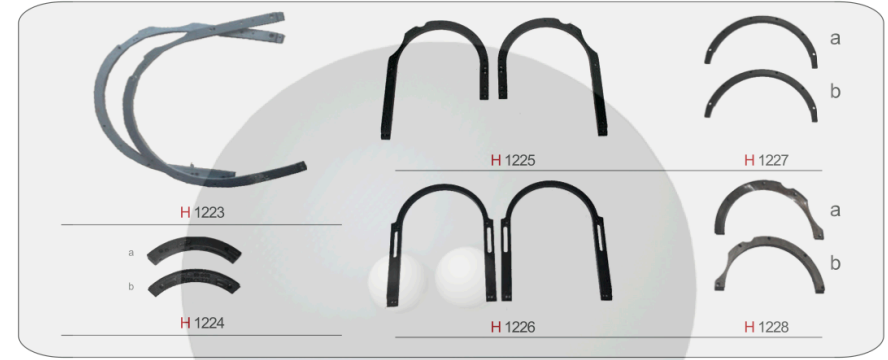
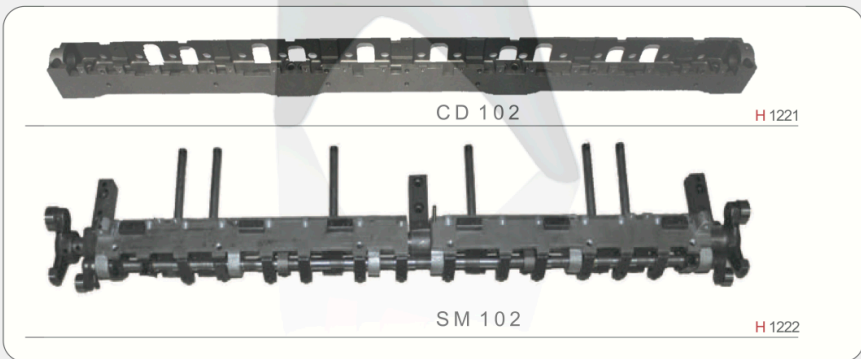
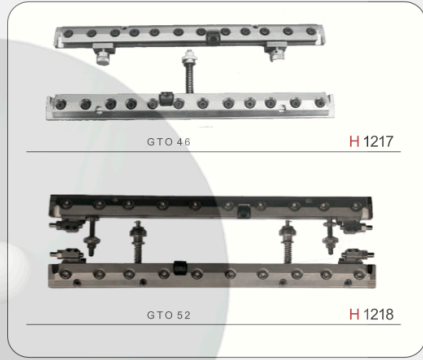

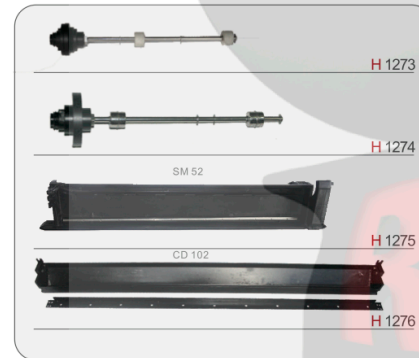
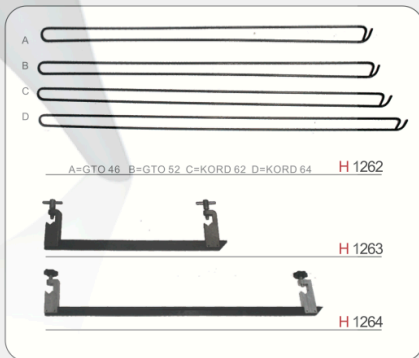
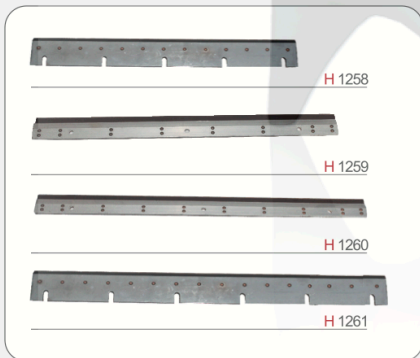
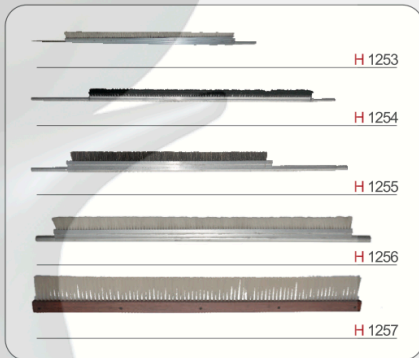
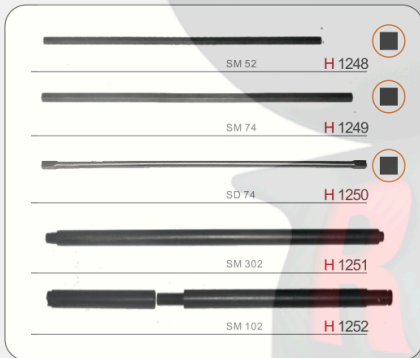
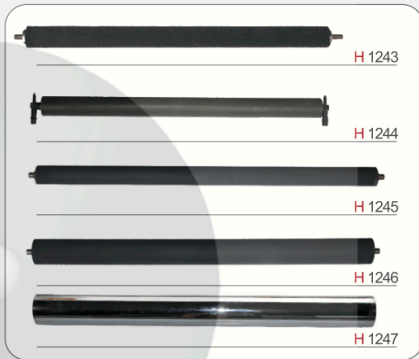

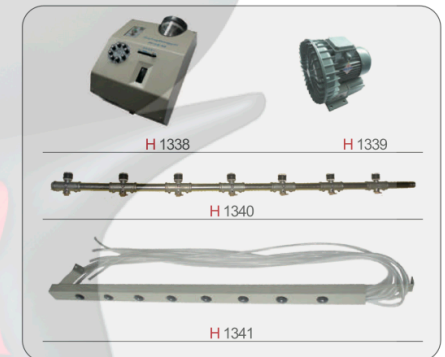
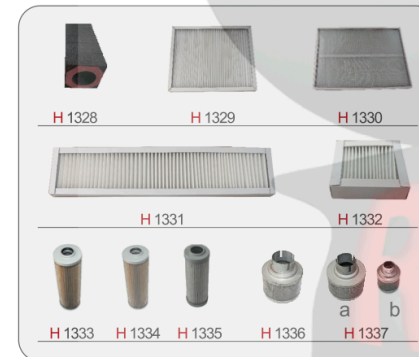
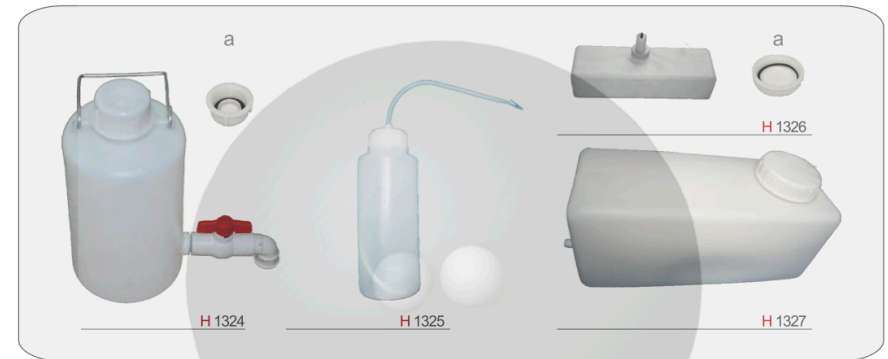
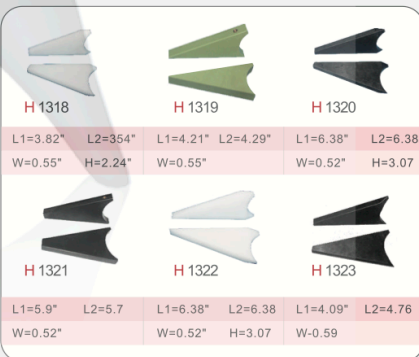
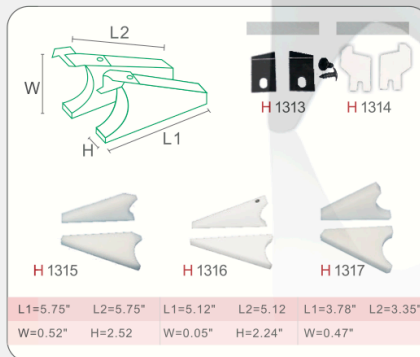
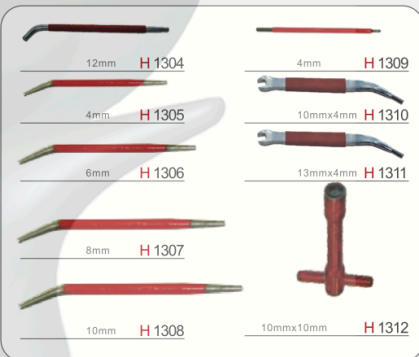
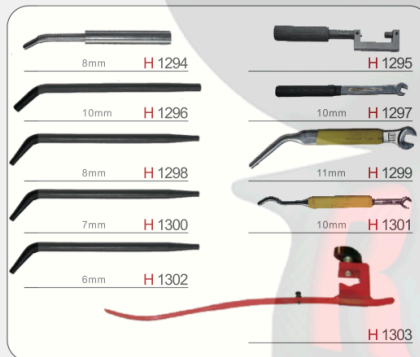

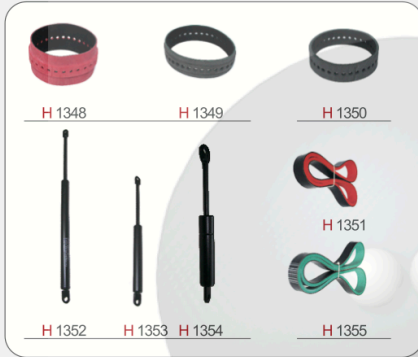

Belt Description	Belt Description
IMPORTED BELTS	LOCAL BELTS
0.8*25*30000mm	1*30*30000mm
0.8*28*30000mm	1.2*20*30000mm
1*20*30000mm	1.2*25*30000mm
1*25*30000mm	1.2*28*30000mm
1*28*30000mm	1.2*40*30000mm
1*30*30000mm	1.2*50*30000mm
LOCAL BELTS	
1*25*30000mm	1.5*25*30000mm
1*28*30000mm	1.5*28*30000mm
	2*28*30000mm

Model	Type	Length (mm)	# of Tooth	Part Number	
H 1365	GTO46 with motor	28*9*900	900	00.270.0046	
H 1366	GTO46	460PJ	1168	10	00.270.0047
H 1367	GTO52	28*9*950	950		
H 1368	GTO52	520PJ	1321	16	00.270.0072
H 1369	MOV	1715PL	1715	15	00.270.0086
H 1370	MO	41*14*1300LI	2322V486		00.580.1337
H 1371	MO	820PJ	2083PJ	24	00.270.0104
H 1372	MOV	490PJ	1244-D PJ	24	00.270.0089
H 1373	102V	2134PL		19	00.270.0084
H 1374	102V	4470PL		19	00.270.0100
H 1375	102Z	2362PL		20	00.270.0052
H 1376	102F	2197PL		19	00.270.0101
H 1377	102VP	4622PL		12	00.270.0051
H 1378	SORK	3327		12	00.270.0035
H 1379	SORK	3696		12	00.270.0036
H 1380	SM74	1613PL		15	00.270.0108
H 1381	SM74	550PJ	1397	22	00.270.0137
H 1382	SM74	720PL	1841	19	00.270.0133
H 1383	SM74	1613-APL		23	00.270.0123
H 1384	SM74	1752-EPL		23	00.270.0112
H 1385	GTO52 Main Motor	770J	1956	20	50 wide
H 1386	SM 102	2997PL	2997	19	
H 1387	PM74	2324		13	00.270.0147
H 1388	MO	575J	1445	24	56 wide
H 1389	SM 74	1650		24	105 wide
H 1390	PM74	880L	2235	14	66 wide
H 1391	SM 102	2743PL		12	55 wide

T5-390-15	T5-340-17	T10-840-14
T5-690-16	T5-780-15	T10-780-25
T5-780-16	T5-690-16	T10-840-15
T5-990-25	T5-365-10	T10-1260-60
T5-340-10	T5-200-8	T10-880-32
T5-280-8	T5-340-16	T10-2250-18
T5-390-8	T5-200-8	T10-1110-32
T5-280-8	T5-815-17	T10-840-32
T5-350-10	T5-1200-25	T10-1080-45
T5-280-8	T5-440-10	T10-1150-20
T5-940-16	T10-840-16	T10-1110-50
T5-215-10	T10-720-25	T10-880-35
T5-355-15	T10-1260-50	

Model	Size (mm)
SM102	2015*28
SM74(Slow Down)	230*20
GTO52	1220*89
SM52	950*60
MO	1350*25
SORD	1440*28
RVK3B/600	Hole 2886*80
R700	1977*28
R800	2050*28
KOMORI L26	1680*25
KOMORI L40	2300*25
MITSUBISHI3F/3E	1980*24

Special Sizes can be ordered





MAN ROLAND



MAN ROLAND



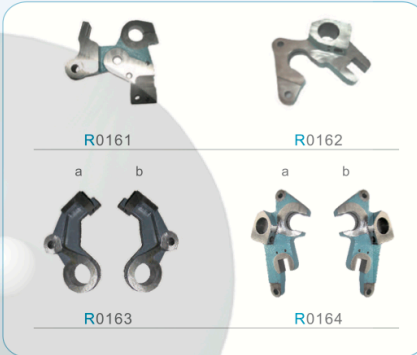

MAN ROLAND

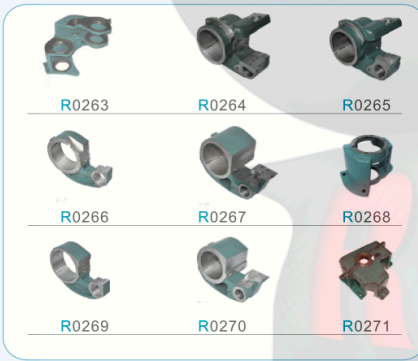

MAN ROLAND



MAN ROLAND



MAN ROLAND



MAN ROLAND



MAN ROLAND



MAN ROLAND

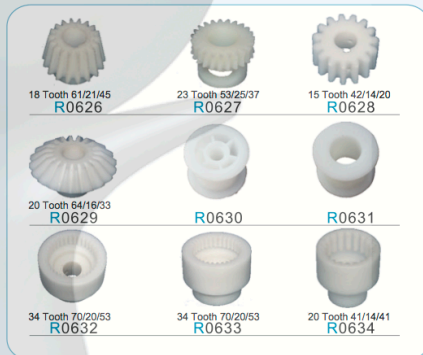
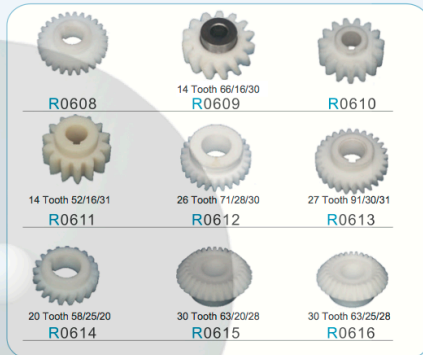

MAN ROLAND



MAN ROLAND



MAN ROLAND

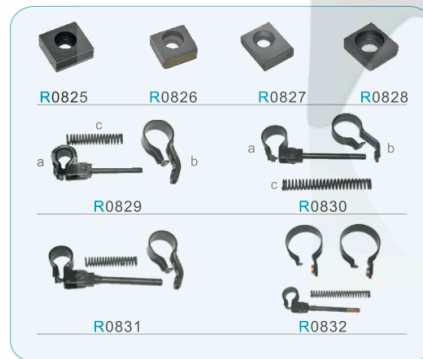

MAN ROLAND

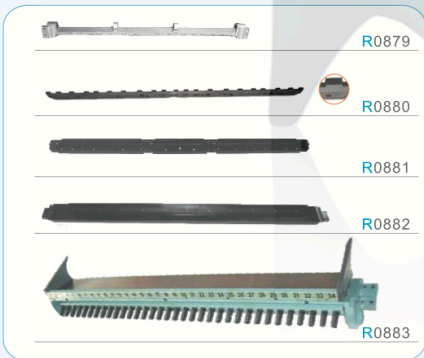
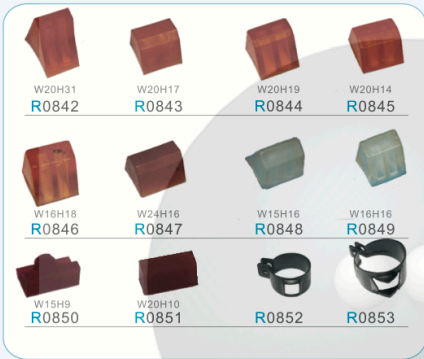

MAN ROLAND

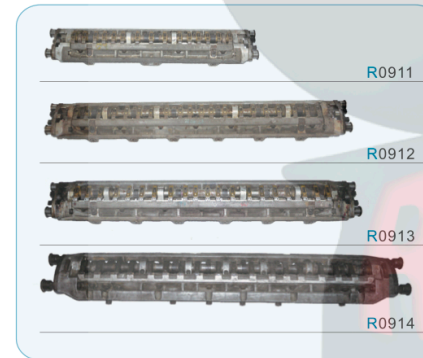

MAN ROLAND



MAN ROLAND

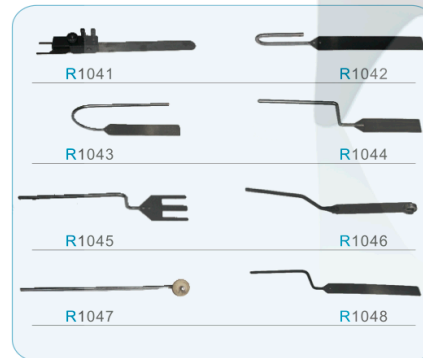
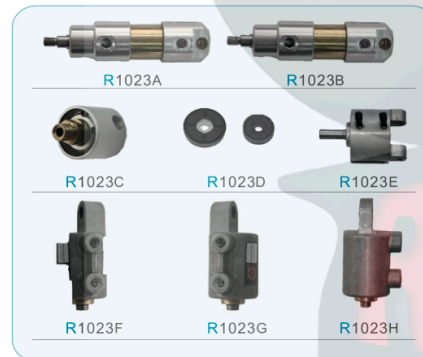

MAN ROLAND

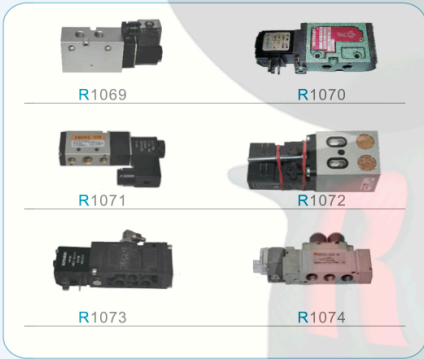
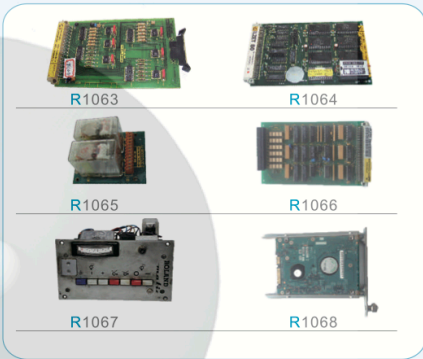
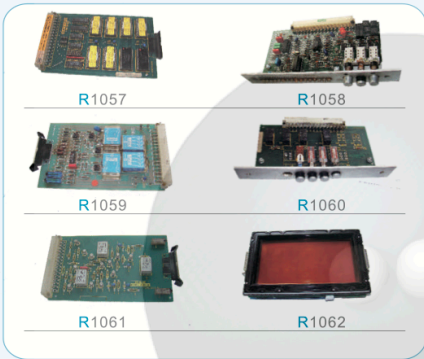

MAN ROLAND



MAN ROLAND

KOMORI

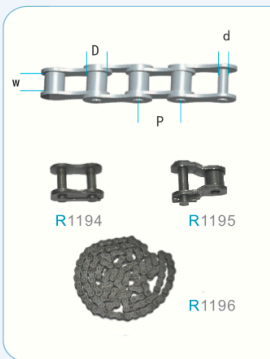

KCM Chain Type	Section P	Width w	Diameter D	Chain d
KCM06B	9.525	5.72	6.35	3.28
KCM08B	12.7	7.75	8.51	4.45
KCM10B	15.875	9.65	10.16	5.08
KCM12B	19.05	11.68	12.07	5.72
KCM16B	25.4	17.02	15.88	8.28
KCM20B	31.75	19.05	19.05	10.19
KCM40	12.7	7.95	7.95	3.97
KCM50	15.875	9.53	10.16	5.09
KCM60	19.05	12.7	11.91	5.96
KCM80	25.4	15.88	15.88	7.94

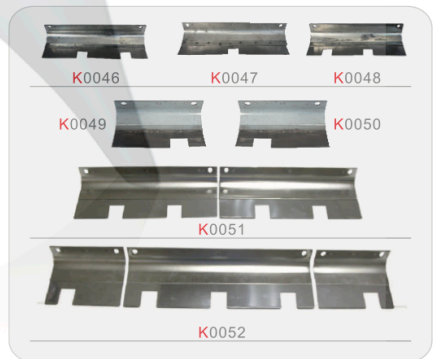

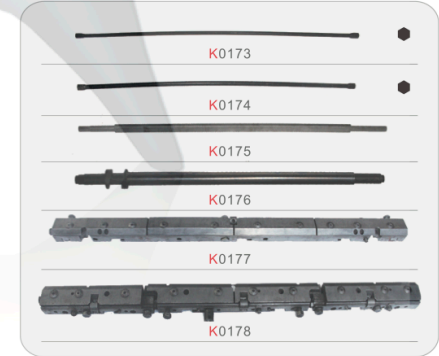
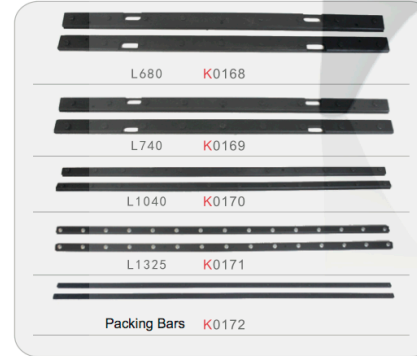



KOMORI



K0286



K0287



K0288



K0289



K0290



K0291



K0292



K0293



K0294



K0295



K0296



K0297



K0298



K0299



K0300



K0301



K0302



K0303



K0304



K0305



K0306



K0307



K0308



K0309



K0310



K0311



K0312

KOMORI



K0313



K0314



K0315



K0316



K0317



K0318



K0319

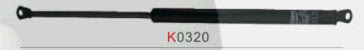

K0320

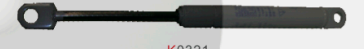

K0321



K0322



K0323



K0324



K0325



K0326



K0327



K0328



KOMORI

KOMORI



K032A K032B K032C



K0332 K0333 K0334



K0329 K0330 K0331



K0335 K0336 K0337



K0338 K0339 K0340



K0344 K0345 K0346



K0341 K0342 K0343



K0347 K0348 K0349



K0350 K0351 K0352



K0356 K0357 K0358



K0353 K0354 K0355



K0359 K0360 K0361



K0362 K0363 K0364



K0368 K0369 K0370



K0365 K0366 K0367



K0371 K0372 K0373



K0374 K0375



K0380 K0381



K0376 K0377



K0382 K0383

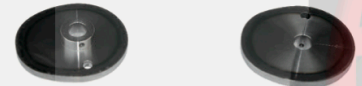

K0378 K0379



K0384 K0385



K0386 K0387



K0390 K0391



K0388 K0389



K0392 K0393



KOMORI



KOMORI

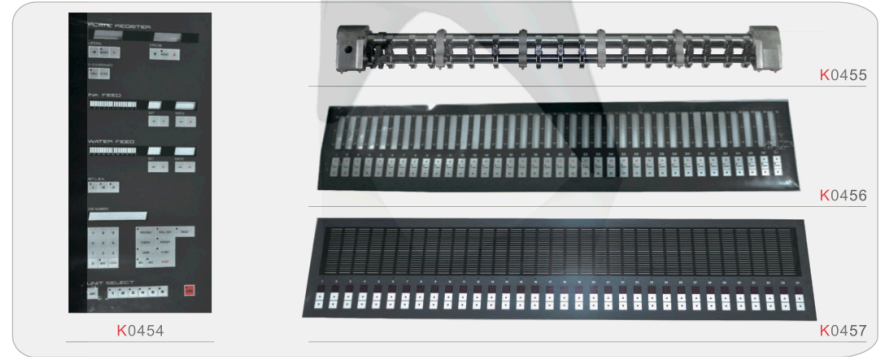

KOMORI

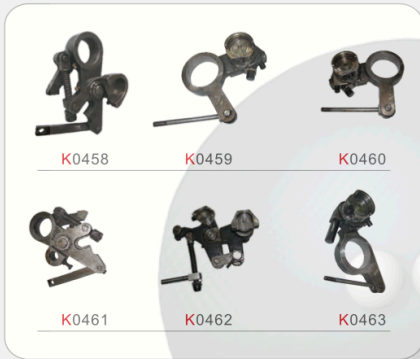

KOMORI



KOMORI



KOMORI



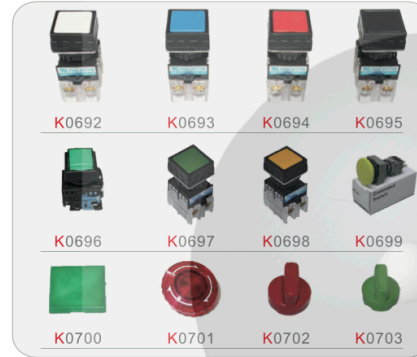

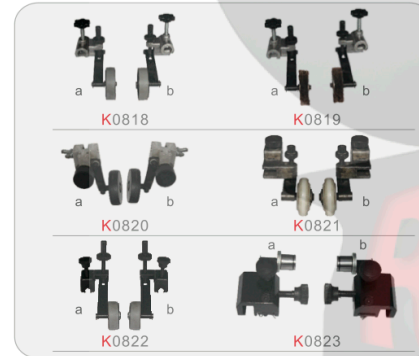

MITSUBISHI

MITSUBISHI



M 0001 M 0002 M 0003



M 0004 M 0005 M 0006



M 0007 M 0008 M 0009



M 0010 M 0011 M 0012 M 0013



M 0014 M 0015 M 0016 M 0017



M 0049 M 0050 M 0051



M 0052 M 0053 M 0054



M 0055 M 0056 M 0057



M 0058 M 0059 M 0060



M 0061 M 0062 M 0063



M 0064 M 0065 M 0066

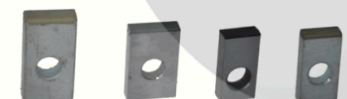

M 0018 M 0019 M 0020 M 0021



M 0022 M 0023 M 0024 M 0025



M 0026 M 0027 M 0028



M 0029 M 0030 M 0031



M 0032 M 0033 M 0034



M 0067 M 0068 M 0069



M 0070 M 0071 M 0072



M 0073 M 0074



M 0075 M 0076 M 0077 M 0078



M 0079 M 0080 M 0081 M 0082



M 0035 M 0036 M 0037 M 0038



M 0039 M 0040 M 0041 M 0042



M 0043 M 0044 M 0045



M 0046 M 0047 M 0048



M 0083 M 0084 M 0085 M 0086



M 0087 M 0088 M 0089 M 0090



M 0091 M 0092



M 0093 M 0094 M 0095

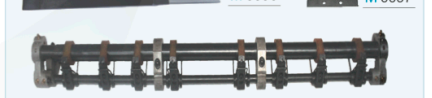

M 0096 M 0097

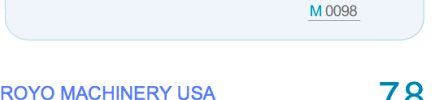

M 0098



MITSUBISHI - KBA

MITSUBISHI - KBA



AKIYAMA - RYOBI - SAKURAI - HAMADA

AKIYAMA - RYOBI

SAKURAI - HAMADA

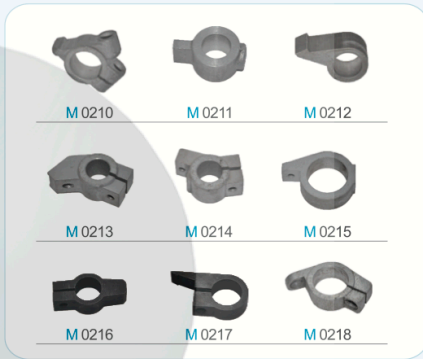

REPLACEMENT PARTS - OTHERS

STITCHING MACHINES

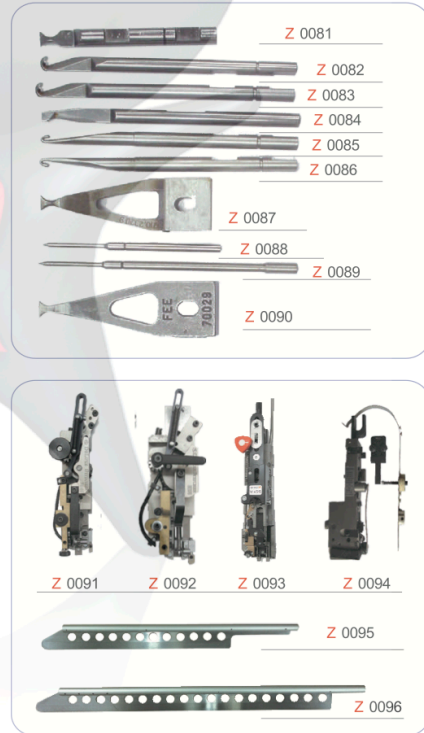
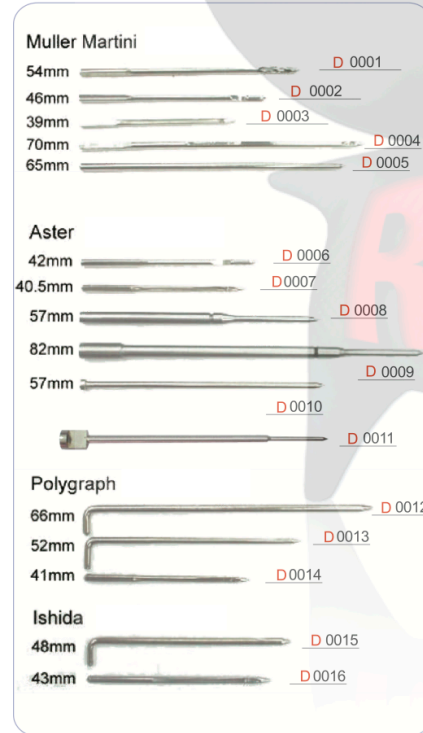
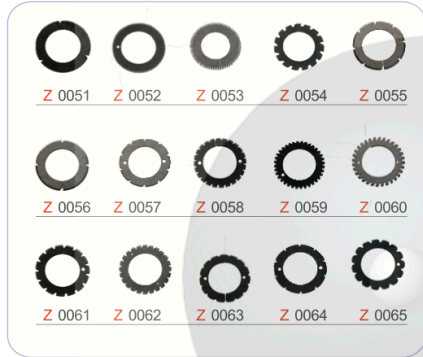
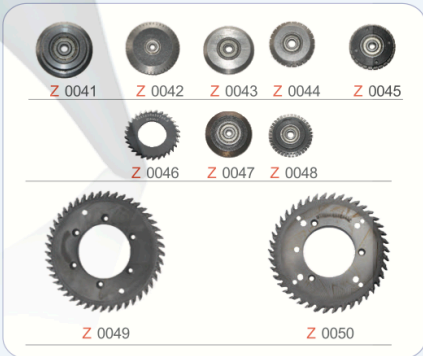
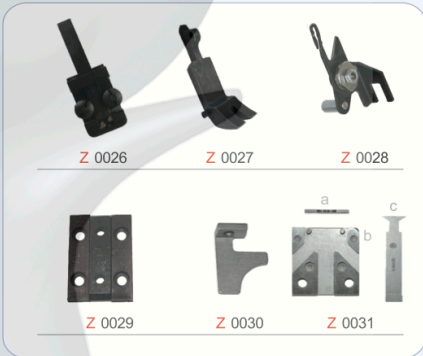
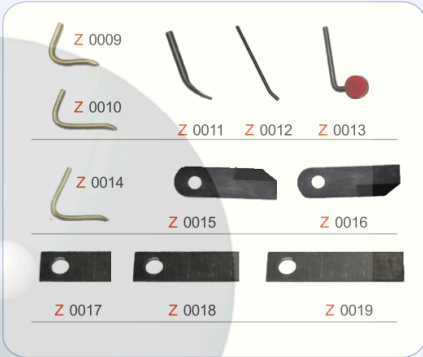
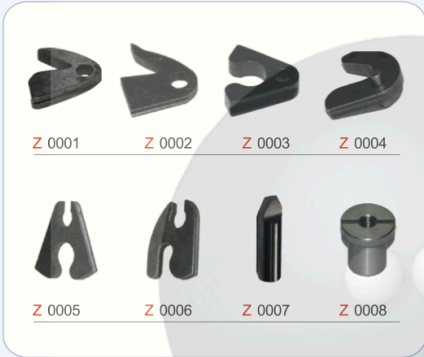

REPLACEMENT PARTS - OTHERS

PAPER CUTTERS



REPLACEMENT PARTS - OTHERS

NUMBERING MACHINES

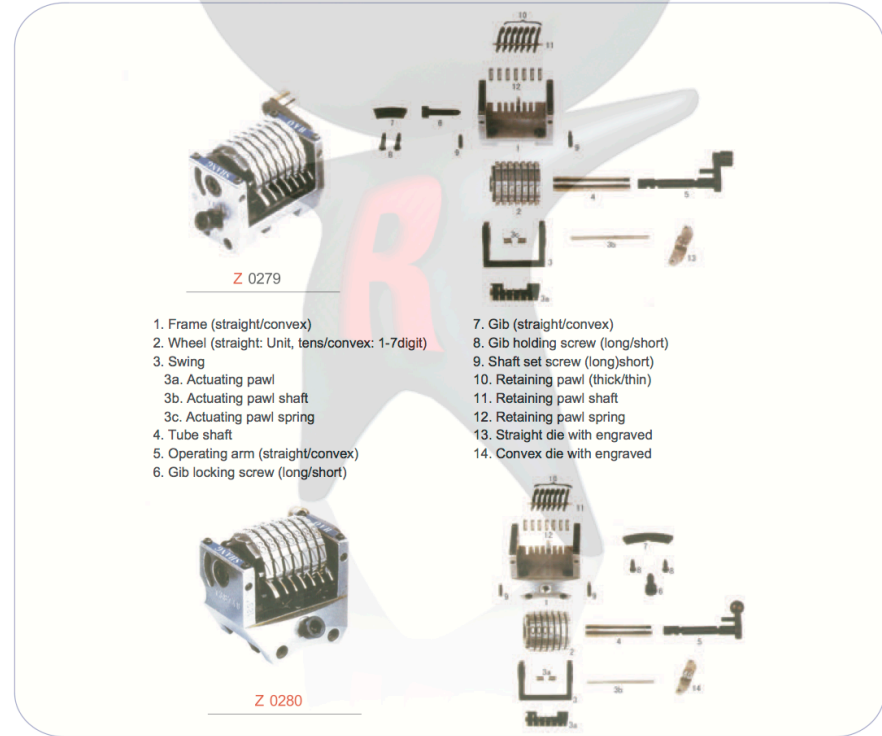
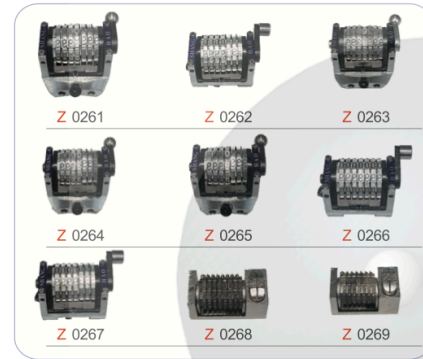
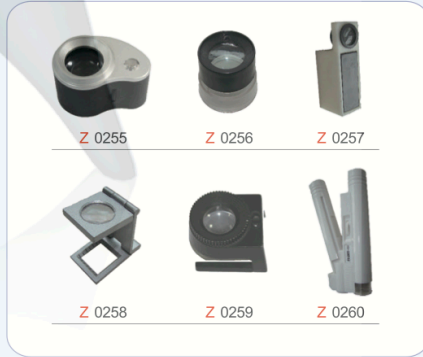
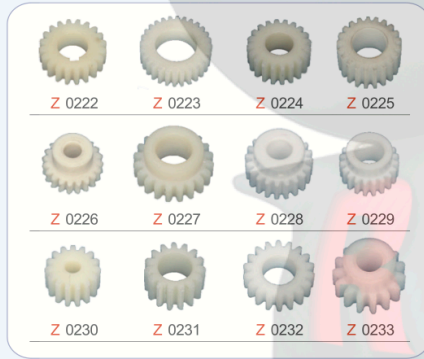
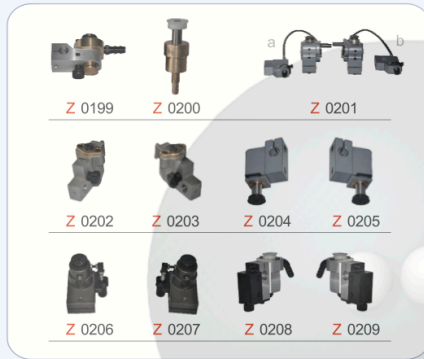

CONSUMABLES

FILTERS

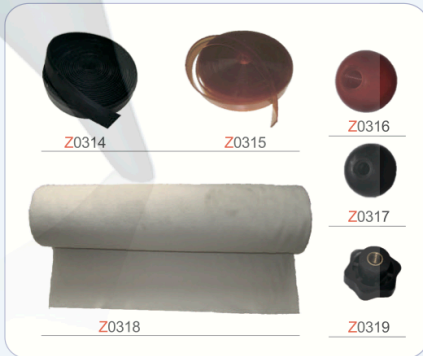

CONSUMABLES

TOOLS

Underpacking Film

1030X760mm
1450X1150mm
1300mmX50m/roll

Z 0332

045 0.18w/ 037	045 0.25w/ 093	045 0.40w/ 157
045 0.15w/ 051	045 0.20w/ 110	045 0.45w/ 177
045 0.25w/ 075	045 0.35w/ 138	045 0.50w/ 197

Anti Marking Paper

Model: 180#, 320#
1150mmx20m / Volume
1300mmx10m / Volume

Z 0333

Z 0334

Cutting Sticks

Z 0335

Model	Size (mm)	Model	Size (mm)	Model	Size (mm)
P	92 10x4.5x930	ITOH	15.88x15.88x1192/1335	W	13x13x1157/1320
O	115 10x4.5x1160		16x16x1192/1335	H	15x15x1157
L	137 10x4.5x1380	OTHER	10x 10 15x15 19x19	O	18x4x1510
A	145 10x4.5x1460		16x16 21x21 20x20	E	24x4x292/300
R	155 10x4.5x1560	Muller	10x10x1000	M	24x4x1000/1050
		Martini	20x10x318/1000	B	
				E	
				R	
				G	

Under packing Paper

Z 0336

Size L x W (mm)
730x595
1030x795
1050x780
1450x1150

Color	Grain	Brown	Green	Golden	Lemon	Blue	grey
Thk(mm)	0.1	0.15	0.2	0.25	0.3	0.4	0.5
Thk(in.)	0.04"	0.06"	0.08"	0.10"	0.12"	0.16"	0.18"

DESCRIPTION

Z 0337

a Woven outer main air line 9mm ID	j Reinforced compressor hose 63mm ID	s Blanket wash blue water tube
b Pneumatic tubing 12mm OD	k Extreme pressure air cabinet hose 40mm ID	t Blanket wash black spirit tube
c Pneumatic tubing 8mm OD	l Extreme pressure air cabinet hose 63mm ID	u 12mm OD 8mm ID 48mm OD
d Pneumatic tubing 6mm OD	m Insulated water hose 12.5mm ID	v 8mm OD 5mm ID 110mm OD
e Pneumatic tubing 4mm OD	n Blanket wash drain hose	w 6mm OD 4mm ID 85mm OD
f Reinforced compressor hose 13mm ID	o Feeder head air hose 13mm ID	x 4mm OD 2.5mm ID 73mm OD 64 ID
g Reinforced compressor hose 16mm ID	p Feeder head air hose 10mm ID	y 3mm OD 2mm ID 56mm OD
h Reinforced compressor hose 25mm ID	q Feeder head air hose 6mm ID	z 22mm OD 15mm ID
i Reinforced compressor hose 40mm ID	r 1/4"reinforced hose for Puffer Gun	z1 13mm OD 6mm ID

Z 0338A

Z 0338B

Z 0338C

Z 0338D

Z 0338E

Z 0338F

Z 0338G

QRST

Z 0338H

Z 0338I

Z 0338K

Z 0338L

Z 0338M

Z 0338N

Z 0338P

Z 0338Q

Z 0338R

Z 0338S

Z 0338T

Z 0338U

Z 0338V

Z 0338

Z 0339

Z 0340

Z 0341

Z 0342

Z 0343

Z 0344

Z 0345

Z 0346

Z 0347

Z 0348

Z 0349

Z 0350

Z 0351

Z 0352

Z 0353

Z 0354

Z 0355

Z 0356

Z 0357

Z 0358

Z 0359

Z 0360

Z 0361

Z 0362

Z 0363

Z 0364

Z 0365

Z 0366

Z 0367

Z 0368

Z 0369



TOOLS

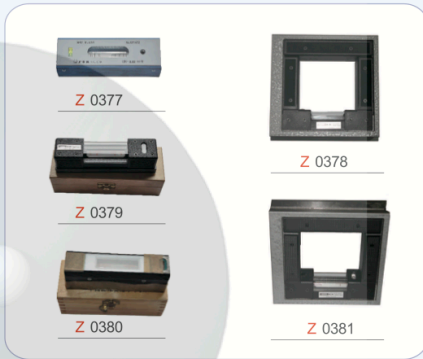

TOOLS

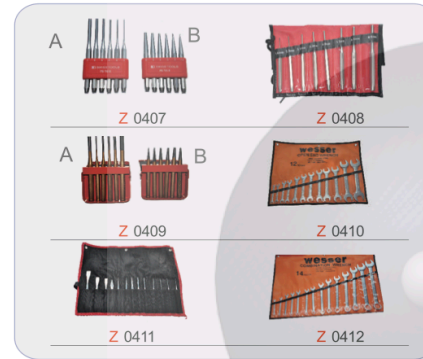

BRUSH WHEELS

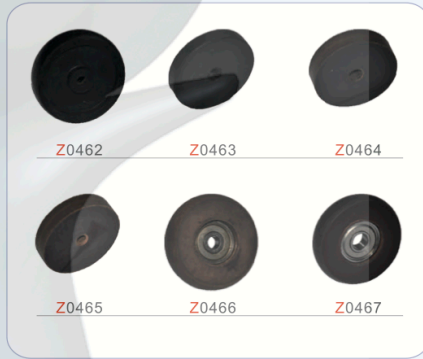
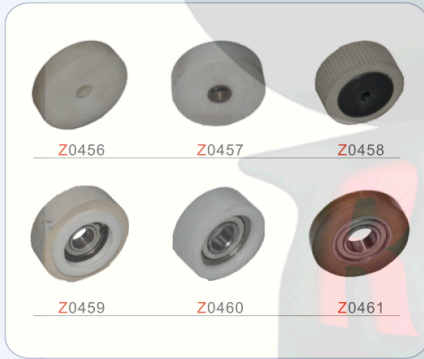

BRUSH WHEELS

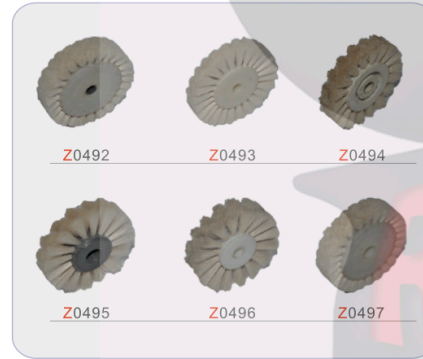
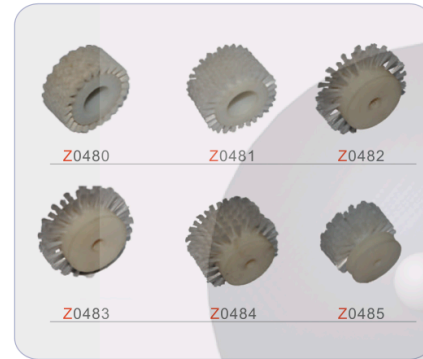

RUBBER SUCKERS

code OD ID H Z0516 50 16 50	code OD ID H Z0517 25 6 16	code OD ID H Z0518 18 4 17	code OD ID H Z0519 18 6 12
code OD ID H Z0520 20 8 18	code OD ID H Z0521 24 6 15	code OD ID H Z0522 64 10 25	code OD ID H Z0523 32 8 20
code OD ID H Z0524 20 6 8	code OD ID H Z0525 15 6 10	code OD ID H Z0526 15 5 4	code OD ID H Z0527 30 6 16
code OD ID H Z0528 34 8 18	code OD ID H Z0529 27 5 18	code OD ID H Z0530 28 8 28	code OD ID H Z0531 18 6 11
code OD ID H Z0532 28 8 28	code OD ID H Z0533 30 8 15	code OD ID H Z0534 16 9 17	code OD ID H Z0535 18 5 18
code OD ID H Z0536 13 4 12	code OD ID H Z0537 22 6 22	code OD ID H Z0538 10 5 16	code OD ID H Z0539 22 7 22
code OD ID H Z0540 45 18 11	code OD ID H Z0541 32 6 10	code OD ID H Z0542 26 6 20	code OD ID H Z0543 15 5 10
code OD ID H Z0544 25 6 16	code OD ID H Z0545 20 5 12	code OD ID H Z0546 24 6 16	code OD ID H Z0547 34 8 18



RUBBER SUCKERS

code OD ID H Z0548 25 6 16	code OD ID H Z0549 22 6 15	code OD ID H Z0550 15 7 22	code OD ID H Z0551 22 6 22
code OD ID H Z0552 22 6 15	code OD ID H Z0553 22 7 2	code OD ID H Z0554 34 6 16	code OD ID H Z0555 20 3 14
code OD ID H Z0556 28 8 8	code OD ID H Z0557 20 3 14	code OD ID H Z0558 22 6 8	code OD ID H Z0559 18 6 12
code OD ID H Z0560 19 6 15	code OD ID H Z0561 28 16 10	code OD ID H Z0562 28 16 10	code OD ID H Z0563 17 5 12
code OD ID H Z0564 15 6 12	code OD ID H Z0565 15 6 12	code OD ID H Z0566 12 7 8	code OD ID H Z0567 20 4 18
code OD ID H Z0568 25 6 16	code OD ID H Z0569 20 6 4	code OD ID H Z0570 22 5 10	code OD ID H Z0571 22 6 5
code OD ID H Z0572	code OD ID H Z0573 20 5 9	code OD ID H Z0574 16 5 32	code OD ID H Z0575 16 5 32
code OD ID H Z0576 30 6 12	code OD ID H Z0577 45 7 25	code OD ID H Z0578 27 12 20	code OD ID H Z0579 28 6 8



RUBBER SUCKERS

code OD ID H Z0580 20 6 14	code OD ID H Z0581 20 6 14	code OD ID H Z0582 18 4 17	code OD ID H Z0583 18 6 8
code OD ID H Z0584 32 10 26	code OD ID H Z0585 9 3 8	code OD ID H Z0586 22 5 4	code OD ID H Z0587 28 8 8
code OD ID H Z0588 14 7 8	code OD ID H Z0589 28 8 28	code OD ID H Z0590 20 6 24	code OD ID H Z0591 20 5 14
code OD ID H Z0592 10 6 14	code OD ID H Z0593 22 6 12	code OD ID H Z0594 15 6 10	code OD ID H Z0595
code OD ID H Z0596 32 8 18	code OD ID H Z0597 25 10 38	code OD ID H Z0598 17 6 7	code OD ID H Z0599 20 5 24
code OD ID H Z0600 20 6 8	code OD ID H Z0601 15 5 12	code OD ID H Z0602 28 16 10	code OD ID H Z0603 20 12 22
code OD ID H Z0604 18 8 8	code OD ID H Z0605 18 4 17	code OD ID H Z0606 18 14 32	code OD ID H Z0607 16 6 24
code OD ID H Z0608 22 11 10	code OD ID H Z0609 22 6 8	code OD ID H Z0610 12 7 8	code OD ID H Z0611 15 5 4

RUBBER SUCKERS

code OD ID H Z0612 16 6 13	code OD ID H Z0613 16 3 13	code OD ID H Z0614 20 4 18	code OD ID H Z0615 21 15 13
code OD ID H Z0616	code OD ID H Z0617	code OD ID H Z0618	code OD ID H Z0619
code OD ID H Z0620 26 5 6	code OD ID H Z0621	code OD ID H Z0622	code OD ID H Z0623



Flat Disks			
code	OD	ID	T
Z0624	32mm	13mm	0.5mm
Z0625	32mm	13mm	0.8mm
Z0626	32mm	13mm	1.0mm
Z0627	35mm	15mm	0.5mm
Z0628	35mm	15mm	0.8mm
Z0629	35mm	15mm	1.0mm
Z0630	38mm	15mm	0.5mm
Z0631	38mm	15mm	0.8mm
Z0632	38mm	15mm	0.8mm

Flat Disks			
code	OD	ID	T
Z0633	32mm	13mm	0.5mm
Z0634	32mm	13mm	0.8mm
Z0635	32mm	13mm	1.0mm
Z0636	35mm	15mm	0.5mm
Z0637	35mm	15mm	0.8mm
Z0638	35mm	15mm	1.0mm
Z0639	38mm	15mm	0.5mm
Z0640	38mm	15mm	0.8mm
Z0641	38mm	15mm	0.8mm

Silicon Flat Disks			
code	OD	ID	T
Z0642	22mm	4mm	1mm
Z0643	26mm	5mm	1mm
Z0644	30mm	5mm	1mm
Z0645	30mm	7mm	1mm
Z0646	32mm	14mm	1mm
Z0647	35mm	14mm	1mm
Z0648	38mm	14mm	1mm
Z0649	45mm	14mm	1mm

Latex Flat Disks			
code	OD	ID	T
Z0650	22mm	4mm	1mm
Z0651	24mm	7mm	1mm
Z0652	26mm	4mm	1mm
Z0653	30mm	5mm	1mm
Z0654	32mm	14mm	1mm
Z0655	35mm	15mm	1mm
Z0656	38mm	14mm	1mm
Z0657	45mm	14mm	0.8mm



VACUUM PUMPS - COMPRESSORS

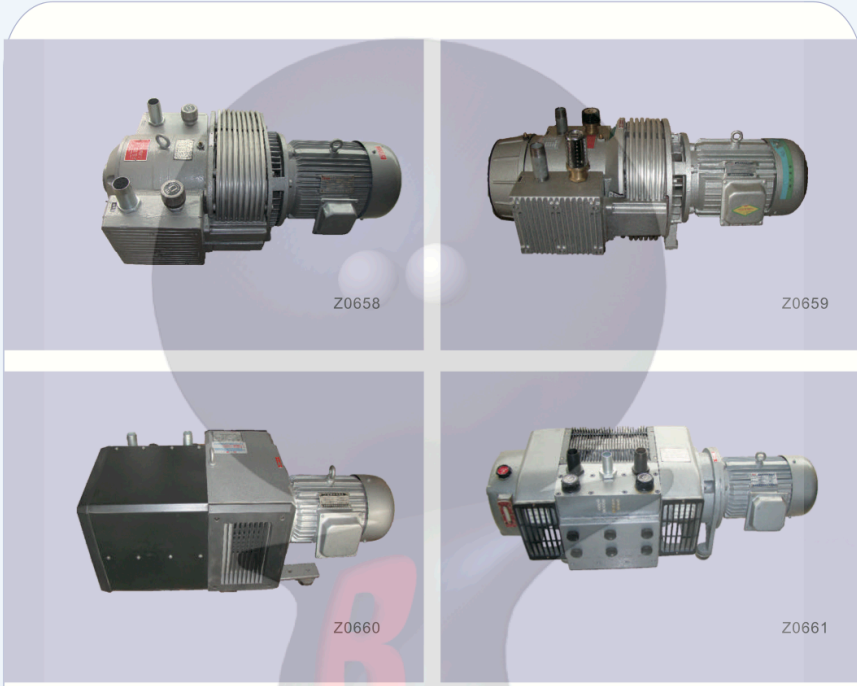

Code	Model	Capacity	Rated Pressure	Rated Vacuum	Supplement Vacuum	Motor Rating	Motor Speed	Noise Level	Weight
		(m3/h)	(Kpa)	(Kpa)	(Kpa)	(KW)	(r/min)	dB	(Kg)
Z0662	ZYBW 40F	40	60	-60	--	2.2	1420	74	65
Z0663	ZYBW 50F	40	60	-60	--	2.2	1420	74	65
Z0664	ZYBW 60F	60	60	-60	-20	3.0	1420	76	84
Z0665	ZYBW 80F	80	60	-60	-30	4.0	1420	77	94
Z0666	ZYBW 100F	100	60	-60	-30	5.5	1420	79	116
Z0667	ZYBW 140F	140	60	-60	-30	7.5	1440	82	133
Z0668	ZYBW 160F	160	60	-60	-30	7.5	1440	78	160

VACUUM PUMPS

COMPRESSORS



code	L	W	T	code	specs
Z0707	130mm	50mm	5mm	Z0716	200x22x1.5
Z0708	165mm	34mm	4mm	Z0717	200x26x1
Z0709	170mm	38mm	4mm	Z0718	200x32x1
Z0710	200mm	30mm	4mm	Z0719	200x32x1.5
Z0711	200mm	40mm	4mm	Z0720	230x32x1
Z0712	227mm	45mm	4mm	Z0721	260x26x1
Z0713	240mm	48mm	4mm	Z0722	260x26x1.5
Z0714	260mm	39mm	4mm	Z0723	300x32x1
Z0715	265mm	45mm	4mm	Z0724	300x32x1.5



CONSUMABLES

Z0725 Z0726 Z0727

Z0728 Z0729 Z0730

Z0731 Z0732 Z0733

Z0734 Z0735 Z0736

Z0737 Z738 Z0739

Z0740 Z0741 Z0742

Z0743 Z0744 Z0745

Z0746 Z0747 Z0748 Z0749

code	L	W	T
Z0750	40mm	25mm	3mm
Z0751	25mm	10mm	6mm
Z0752	32mm	20mm	10mm
Z0753	40mm	25mm	10mm
Z0754	40mm	17mm	12.5mm
Z0755	25mm	16mm	8mm

CONSUMABLES

Z0756 Z0757 Z0758

Z0759 Z0760 Z0761

Z0762 Z0763 Z0764

Z0765

Z0766 Z0767

Z0768

Z0769 Z0770

Z0771 Z0772

Z0773 Z0774

Z0775 Z0776

Z0777 Z0778

Z0779

Z0780 Z0781 Z0782

Z0783

Z0784 Z0785

Z0786 Z0787

Z0788 Z0789

Z0790

Z0791 Z0792 Z0793

Stitching Wire	code	specs
	Z0794	21# 0.80mm
	Z0795	22# 0.75mm
	Z0796	23# 0.70mm
	Z0797	24# 0.60mm
	Z0798	25# 0.55mm
	Z0799	26# 0.50mm
	Z0800	27# 0.45mm
	Z0801	28# 0.40mm





Synthetic and Cotton Dampening Sleeves

Code	Caliber	Roller Diameter mm	Code	Caliber	Roller Diameter mm
44#		25-30	108#	89	61-63
52#	51	35-40	116#	95	68-70
64#	70	40-45	124#	105	74-77
76#	76	45-50	132#	108	85-88
84#	82	50-55	140#	114	90-93
96#	89	57-60	148#	120	96-100

- A. Thickness of Creasing Matrix
- B. Bottom Film
- C. Channel Width
- D. Plastic Strip
- E. Adhesive Film

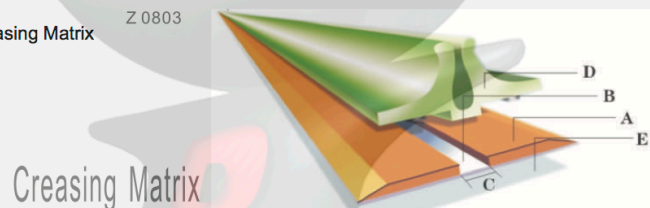

Carton Thickness (gsm)	Carton Thickness (mm)	Height of Creasing Rules (mm)						Common Creasing Rules	
		23.50	23.40	23.30	23.20	23.10	2300	23.24	22.9
200	0.28mm	0.3*1.0	0.4*1.0					0.5x1.0	
250	0.35mm	0.3*1.2	0.4*1.2	0.5*1.2				0.5x1.2	
300	0.42mm	0.3*1.3	0.4*1.3	0.5*1.4				0.5x1.4	
350	0.50mm		0.4*1.4	0.5*1.5	0.6*1.5			0.5x1.5	
400	0.56mm			0.5*1.6	0.6*1.6			0.5x1.6	0.8x1.6
450	0.63mm			0.5*1.7	0.6*1.7	0.7*1.7		0.8x1.7	
500	0.70mm				0.7*1.7	0.8*1.7		0.8x1.7	

PERFECT PERF - CENTER RULES

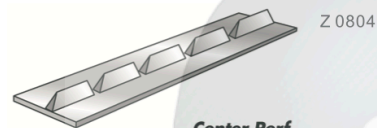

Center Perf

PERF	16TPI	12TPI	8TPI	TPI
Description	Item#	Item#	Item#	Item#
Card 10 ft(3m)	T-304	T306	T-308	T-310
Card 20 ft(6m)	T-305	T-307	T-309	T-311
Paper 10 ft(3m)	T-404	T-406	T-408	T-410
Paper 20 ft(6m)	T-405	T-407	T-409	T-411

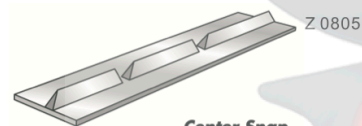

Center Snap

SNAP	4TPI	3TPI
Description	Item#	Item#
Card 10 ft(3m)	T-312	T-314
Card 20 ft(6m)	T-313	T-315
Paper 10 ft(3m)	T-412	T-414
Paper 20 ft(6m)	T-413	T-415



Center Micro-Perf

MICRO-PERF	30TPI	40TPI	50TPI
Description	Item#	Item#	Item#
Paper 10 ft(3m)	T-419	T-420	T-421
Paper 20 ft(6m)	T-416	T-417	T-418

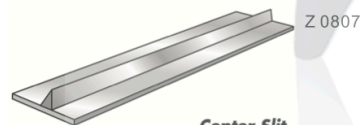

Center Slit

SLIT	Item#
Description	Item#
Card 10 ft(3m)	T-302
Card 20 ft(6m)	T-303
Paper 10 ft(3m)	T-402
Paper 20 ft(6m)	T-403

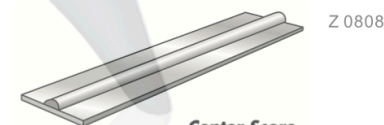

Center Score

SCORE	Item#
Description	Item#
Card 10 ft(3m)	T-300
Card 20 ft(6m)	T-301
Paper 10 ft(3m)	T-400
Paper 20 ft(6m)	T-401



CONSUMABLES

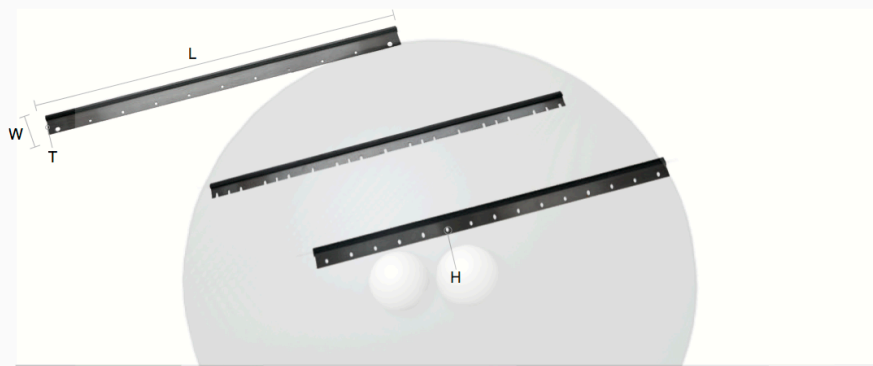

NO.	Model	L (mm)	W(mm)	T(mm)	L(in)	W(in)	T(in)	Holes
Z 0809	Tok Plastic	283	43	3	11 5/32	1 11/16	1/8	4
Z 0810	Tok(Metal)	283	43	0.5	11 5/32	1 11/16	1/6	4
Z 0811	Quickmaster	375	43	3	14 3/4	1 11/16	1/8	5
Z 0812	GTO46	500	60	0.5	19 11/16	2 3/8	1/64	5
Z 0813	GTO46 Numbering Unit	448	40	6	17 5/8	1 9/16	15/64	3
Z 0814	GTO52	560	60	0.5	22 1/16	2 3/8	1/64	6
Z 0815	GTO52 Numbering Unit	508	40	6	20	1 9/16	15/64	3
Z 0816	MO	710	60	0.5	27 15/16	2 3/8	1/64	8
Z 0817	MO Blanket(Short)	692	60	0.5	27 1/4	2 3/8	1/64	7
Z 0818	MO (Rigid)	710	60	2	27 15/16	2 3/8	5/64	8
Z 0819	MO Numbering Unit	648	52	6	25 1/2	2 1/16	15/64	3
Z 0820	Speedmaster 52	605	46	0.5	23 13/16	1 3/16	1/64	7
Z 0821	Speedmaster 72	790	60	0.5	31 3/32	2 3/8	1/64	11
Z 0822	Speedmaster 72 VP	753	40	0.5	29 5/8	1 9/16	1/64	9
Z 0823	Speedmaster 74	820	57	0.5	32 9/32	2 1/4	1/64	9
Z 0824	Speedmaster 102	1090	60	0.5	42 29/32	2 3/8	1/64	11
Z 0825	Speedmaster 102(With 11 slots)	1090	60	0.5	42 29/32	2 3/8	1/64	11
Z 0826	Speedmaster 102A/W	1042	60	0.5	41	2 1/4	1/64	11
Z 0827	Speedmaster 102AW New	1042	57	0.5	41	2 3/8	1/64	11
Z 0828	Speedmaster 102VP	1052	40	0.5	41 13/32	1 9/16	1/64	11
Z 0829	Rotaspeed	1050	60	0.5	41 11/32	2 3/8	1/64	11
Z 0830	KOR	600	50	2	23 5/8	1 31/32	5/64	10
Z 0831	KORA	622	50	2	24 1/2	1 31/32	5/64	10
Z 0832	KORD62	650	50	2	25 19/32	1 31/32	5/64	10
Z 0833	KORD64	690	50	2	27 5/32	1 31/32	5/64	12

CONSUMABLES



NO.	Model	L (mm)	W(mm)	T(mm)	L(in)	W(in)	T(in)	Holes
Z 0834	KORS	760	50	2	29 15/16	1 31/32	5/64	12
Z 0835	SOR Rigid	890	50	2	35	1 31/32	5/64	10
Z 0836	SOR Z Rigid	890	51	2	35	2	5/64	9
Z 0837	SORD Flexi	960	60	0.5	37 25/32	2 3/8	1/64	10
Z 0838	SORD Rigid	960	50	2	37 25/32	1 31/32	5/64	12
Z 0839	SORK Flexi	710	60	0.5	27 15/16	2 3/8	1/64	8
Z 0840	SORK Rigid	721	50	2	28 3/8	1 31/32	5/64	12
Z 0841	SORM Flexi	790	60	0.5	31 3/32	2 3/8	1/64	11
Z 0842	SORM Rigid	790	50	2	31 3/32	1 31/32	5/64	12
Z 0843	SORM Z Flexi Pre 1955	753	42	0.5	29 5/8	1 21/32	1/64	9
Z 0844	SORM Z (9 holes/2 slots)	790	60	0.5	31 3/32	2 3/8	1/64	11
Z 0845	Favorit RF01	720	65	0.5	28 3/8	2 9/16	1/64	8
Z 0846	Favorit RF oB/02/200	800	65	0.5	31 1/2	2 9/16	1/64	8
Z 0847	300(Plastic)	816	60	1	32 1/8	2 3/8	3/64	8
Z 0848	Parva RP/RZP2	920	65	0.5	36 1/4	2 9/16	1/64	10
Z 0849	Parva RP2C	995	65	0.5	39 3/16	2 9/16	1/64	10
Z 0850	Rekord RVK 3B	1100	65	0.5	43 5/16	2 9/16	1/64	11
Z 0851	700New	1100	56	0.5	43 5/16	2 3/16	1/64	13
Z 0852	Ultra VII&VIIB	1710	65	0.5	67 5/16	2 9/16	1/64	16
Z 0853	700(007V/143930)(Plastic)	1102	56	1	43 3/8	2 3/16	3/64	13
Z 0854	700New version W/slots	1102	56	0.5	43 3/8	2 3/16	1/64	13
Z 0855	800V/VW	1410	65	0.5	55 1/2	2 9/16	1/64	13
Z 0856	800VI	1510	65	0.5	59 7/16	2 9/16	1/64	14
Z 0857	Lithrone 26 Flexi	726	36	0.5	28 19/32	1 13/32	1/64	6
Z 0858	Lithrone 28 Flexi	785	42	0.5	30 29/32	1 21/32	1/64	6
Z 0859	Lithrone 28 Flexi(New style)	785	37	0.5	30 29/32	1 15/32	1/64	6
Z 0860	Lithrone 28 Rigid	785	37	2	30 29/32	1 15/32	5/64	6
Z 0861	Lithrone 28 (Spec for UV)	790	36	5.8	31 3/32	1 13/32	7/32	6
Z 0862	Lithrone 40 Flexi	1094	50	0.5	43 1/16	1 31/32	1/64	8
Z 0863	L40 AW(Old 47mm wide)	1110	47	0.5	43 11/16	1 27/32	1/64	15



CONSUMABLES

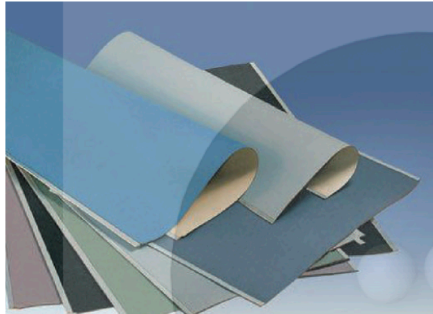

Rubber Blankets

Model	Standard Specs
Z 0865	KORD 62 625*515*1.95mm
Z 0866	KORD 64 677*525*1.95mm
Z 0867	MO 680*575*1.95mm
Z 0868	SORD 920*740*1.95mm
Z 0869	SM 102 1050*810*1.95mm
Z 0870	CD 102 1050*830*1.95mm
Z 0871	CD 74 770*615*1.95mm
Z 0872	GTO 46 460*440*1.95mm
Z 0873	GTO 52 520*445*1.95mm
Z 0874	KOR/KORA 514*625*1.95mm
Z 0875	KORS 584*746*1.95mm
Z 0876	SM 52 170*535*1.95mm
Z 0877	SM 72 603*1514*1.95mm
Z 0878	SORM/SORMZ 603*1514*1.95mm
Z 0879	SOR/SORZ 698*851*1.95mm
Z 0880	SORD/SORDZ 714*921*1.95mm

Ink Fountain Blades

Z 0881	ROLAND PRACTICA00 510*125mm
Z 0882	ROLAND PRACTICA01 661*125mm
Z 0883	ROLAND200 730*145mm
Z 0884	ROLAND FAVORIT RF-OB 730*110mm
Z 0885	ROLAND 1030*143mm
Z 0886	M.A.N GS140 1502*152mm
Z 0887	LITHOMAN48 1430*150mm
Z 0888	FUJI50 530*85mm
Z 0889	FUJI52 530*98mm
Z 0890	KOMORI SPRINT28 734*106mm
Z 0891	KOMORI LITHRONE40 1085*176mm

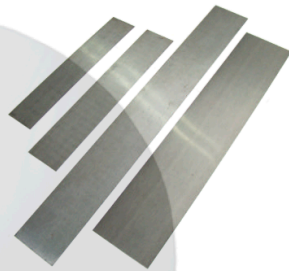

Ink Fountain Blades

Z 0892	HEIDELBERG PLATENT-STELLAT 375*1015mm
Z 0893	HEIDELBERG GTO46 452*86mm
Z 0894	HEIDELBERG GTO52 512*94mm
Z 0895	HEIDELBERG MO65 662*1295mm
Z 0896	HEIDELBERG KORD64 670*102mm
Z 0897	HEIDELBERG KORS72 740*103mm
Z 0898	HEIDELBERG SORM72 730*175mm
Z 0899	HEIDELBERG SORM72 730m*118mm
Z 0900	HEIDELBERG SM74 747*135mm
Z 0901	HEIDELBERG SM102 1030*175mm

Segmented Ink Fountain Blades

Z 0902	HEIDELBERG GTO46 452*86mm
Z 0903	HEIDELBERG GTO52 512*94mm
Z 0904	HEIDELBERG MO65 662*1295mm
Z 0905	HEIDELBERG SORM72 730*175mm
Z 0906	HEIDELBERG SM74 747*135mm
Z 0907	HEIDELBERG SM 102 1030*175mm
Z 0908	ROLAND PRACTICA00 510*125mm
Z 0909	ROLAND200 1030*143mm
Z 0910	ROLAND M.A.N GS140 1430*152mm
Z 0911	LITHOMAN48 1502*150mm
Z 0912	SAKURAI OLIVER72 746*114mm
Z 0913	SAKURAI OLIVER252RP 596*112mm
Z 0914	KOMORI SPRINT28 734*106mm

CONSUMABLES

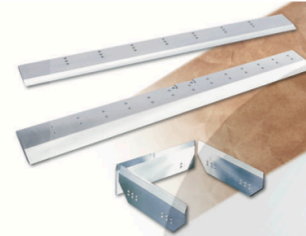

Knife Specification

1605*160*13.7	1605*160*13.7
1065*127*12.7	1605*160*13.7
1080*127*12.7	1410*150*13.7
1100*127*12.7	Three Knife
1390*160*13.7	1300*127*12.7
1390*160*13.7	1095*115*11.7
1520*127*12.7	1790*160*13.7



Model	Diameter	Specification		Volume	Location	Qty	Use
		Face Length	Total Length				
G1	57	1026	1088	2561	2.7.8	3	Ink Roller
G2	60	1026	1088	2709	3.12	2	Ink Roller
G3	62.5	1026	1088	3098	1.9.16	3	Ink Roller
G4	0.65	1026	1088	3238	4.11	2	Ink Roller
G5	0.63	1045	1088	3183	20.21	2	Water Roller
G6	0.63	1057	1100	3219	23	1	Water Roller

Model	Diameter	Specification		Volume	Location	Qty	Use
		Face Length	Total Length				
N1	60	1032	1087	2725		10	
N2	66	1032	1087	3313		10	
N3	72	1032	1087	3650		10	
N4	80	1032	1087	4090		15	
N5	108	1060	1103	5822		5	
N6	78	1037	1087	4006		5	
N7	60	1034	1071	2730		5	
N8	60	1032	1069	2725		1	
N9	85.1	1060	1060	4514		12	Hard Rubber
N10	70						Hard Rubber
N11	56						Hard Rubber
N12	45						Hard Rubber
N13	68						Hard Rubber

